

3 dB Fixed Attenuator SMA Male To SMA Female Up To 3 GHz Rated To 5 Watts With Brass Body

Fairview Microwave carries a broad selection of fixed attenuators with a wide range of attenuation levels, frequency ranges, and power dissipation ranges. Also known as RF pads, RF microwave attenuators lower the amplitude of a signal (or attenuate) a known amount. These attenuator pads can be used in a wide variety of applications including reducing a signal level to protect measurement equipment or other circuitry, extending the range of power meters and amplifiers, and impedance matching circuits by reducing the VSWR seen by adjacent components. RF attenuators can prevent signal overload in amplifiers, receivers and detectors, adjusting the signal level to a range that is optimal.

Few RF components are as commonly used as fixed coaxial attenuators, and Fairview Microwave carries one of the largest in-stock selections and ships them same day. The SA3S5W-03 is a 3 dB Fixed Attenuator that operates from DC to 3 GHz and is rated to 5 Watts. The versatile coaxial package uses SMA male to SMA female connectors and is also REACH and RoHS compliant.

Electrical Specifications

Description	Min	Typ	Max	Units
Frequency Range	DC		3	GHz
Impedance		50		Ohms
Nominal Attenuation		3		dB
Attenuation Accuracy			±0.4	dB
VSWR			1.25:1	
Input Power, CW derated linearly to .5W @125°C			5	Watts
Input Power, Peak 5µs pulse, 1% duty cycle			500	Watts

Mechanical Specifications

Size	
Length	2.76 in [70.1 mm]
Width/Diameter	0.708 in [17.98 mm]
Weight	0.11199 lbs [50.8 g]
Body Material and Plating	Brass

Configuration

Design	Fixed
--------	-------

Connectors

Description	Connector 1	Connector 2
Type	SMA Male	SMA Female
Contact Material & Plating	Beryllium Copper	Beryllium Copper
Outer Conductor Material & Plating	Brass, Nickel	Brass, Nickel
Coupling Nut Material & Plating	Brass, Nickel	
Hex Size	5/16 inch	
Torque	5 in-lbs [0.57 Nm]	



Features:

- Bidirectional
- DC to 3 GHz Frequency Range
- Attenuation 6±0.4 dB
- Max Power 5 Watts (CW)
- VSWR < 1.25:1

Applications:

- Instrumentation
- Precision Measurements
- Prototyping and Characterization
- Production Systems

Fairview Microwave
 1130 Junction Dr. #100
 Allen, TX 75013
 Tel: 1-800-715-4396 / (972) 649-6678
 Fax: (972) 649-6689
www.fairviewmicrowave.com
sales@fairviewmicrowave.com

Body Material & Plating	Brass, Nickel	Brass, Nickel
-------------------------	---------------	---------------

Environmental Specifications

Temperature

Operating Range -55 to +125 deg C

Compliance Certifications (visit www.FairviewMicrowave.com for current document)

RoHS Compliant Yes
 REACH Compliant 12/17/2015

Plotted and Other Data

Notes:

Typical Performance Data

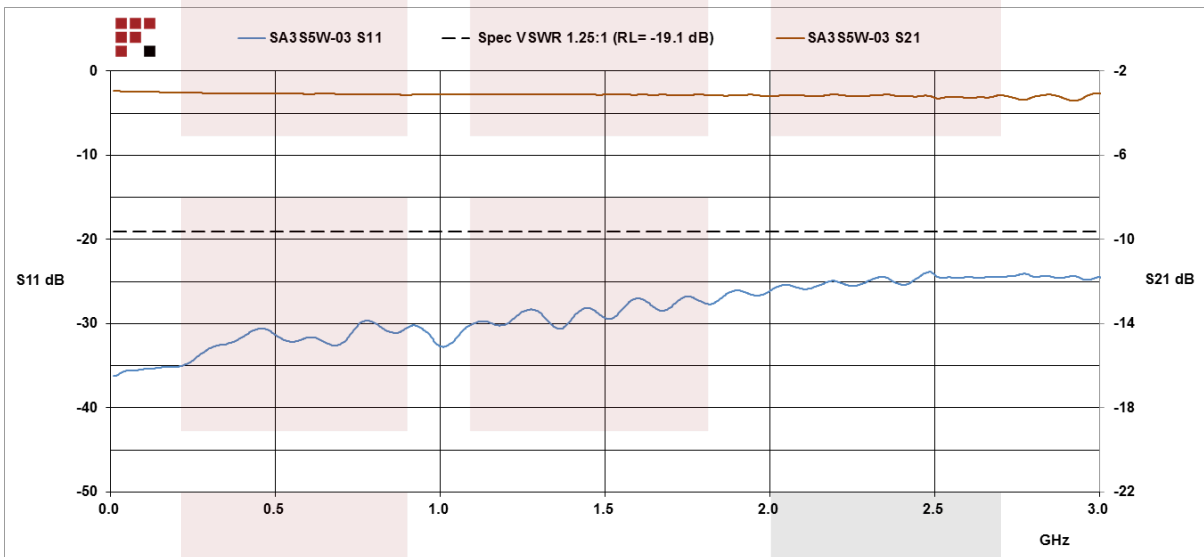

3 dB Fixed Attenuator SMA Male To SMA Female Up To 3 GHz Rated To 5 Watts With Brass Body from Fairview Microwave is in-stock and available to ship same-day. All of our RF/microwave products are available off-the-shelf from our ISO 9001:2008 certified facilities in Allen, Texas. Fairview Microwave is RF on-demand.

For additional information on this product, please click the following link: [3 dB Fixed Attenuator SMA Male To SMA Female Up To 3 GHz Rated To 5 Watts With Brass Body SA3S5W-03](http://www.fairviewmicrowave.com/3db-fixed-attenuator-sma-male-sma-female-5-watts-sa3s5w-03-p.aspx)

URL: <http://www.fairviewmicrowave.com/3db-fixed-attenuator-sma-male-sma-female-5-watts-sa3s5w-03-p.aspx>

The information contained in this document is accurate to the best of our knowledge and representative of the part described herein. It may be necessary to make modifications to the part and/or the documentation of the part, in order to implement improvements. Fairview Microwave reserves the right to make such changes as required. Unless otherwise stated, all specifications are nominal. Fairview Microwave does not make any representation or warranty regarding the suitability of the part described herein for any particular purpose, and Fairview Microwave does not assume any liability arising out of the use of any part or documentation.

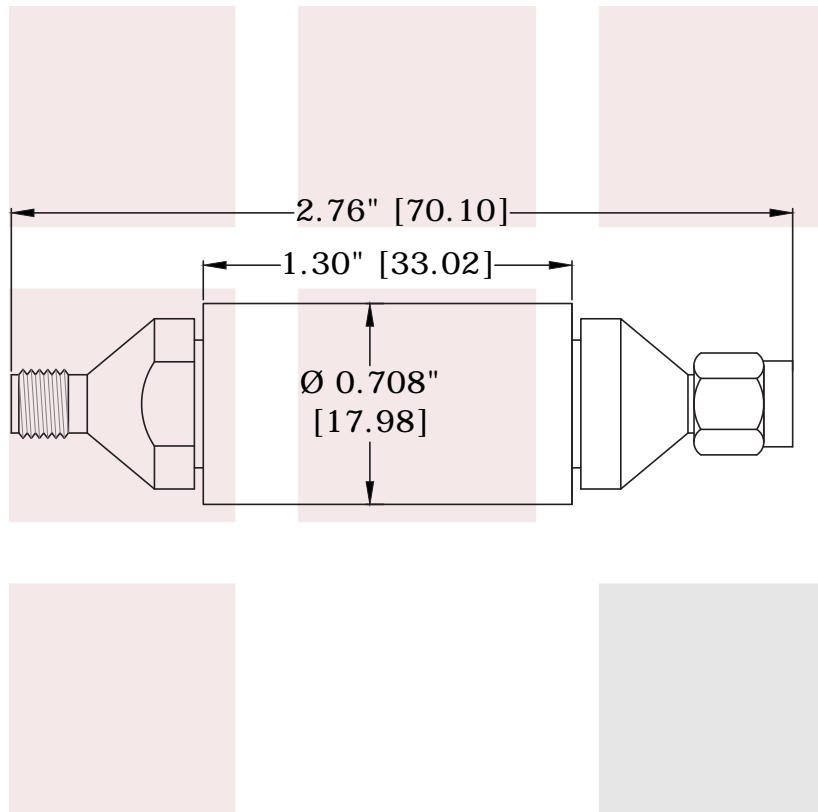

FAIRVIEW MICROWAVE INC. ALLEN, TX 75013 WWW.FAIRVIEWMICROWAVE.COM		NOTES: 1. UNLESS OTHERWISE SPECIFIED ALL DIMENSIONS ARE NOMINAL. 2. ALL SPECIFICATIONS ARE SUBJECT TO CHANGE WITHOUT NOTICE AT ANY TIME. 3. DIMENSIONS ARE IN INCHES [mm].			
TITLE 3 dB Fixed Attenuator SMA Male To SMA Female Up To 3 GHz Rated To 5 Watts With Brass Body		DWG NO SA3S5W-03		CAGE CODE 3FKR5	
CAD FILE	020916	SHEET	SCALE	N/A	SIZE A 5568