

**SPDT Latching 0.03 dB Low Insertion Loss
Repeatability DC to 20 GHz Relay Switch,
Indicators, Self Cut Off, TTL, 1W, 24V, SMA**

The FMSW6336 is a single pole double throw (SPDT) electromechanical switch that operates across a wide frequency range from DC to 20 GHz and has guaranteed insertion loss repeatability of 0.03 dB max over a life span of 10 million switching cycles in a Break Before Make condition. Maximum Insertion loss is 0.5 dB and Isolation is rated up to 65 dB minimum. The model also supports a hot switching limit of up to 1W CW maximum. The Latching Self Cut-Off TTL Control actuator design includes indicators and internally terminated, a +24 Vdc operating voltage, and operates over a temperature range of -25°C to +75°C. The rugged and compact package assembly supports SMA connectors and solder pins for command control capability. And for highly reliable operation, the model is guaranteed to meet MIL-STD-202 environmental test conditions that include temperature cycle, vibration, and shock.

Electrical Specifications

Switch Type	SPDT, Reflective
Actuator Type	Latching
Switching Sequence	Break Before Make
Actuator Options	Indicators, Self Cut Off, TTL Logic
TTL Control	on: 3 to 7 Volts off: 0 to 0.8 Volts
TTL Control Current	0.8 mA at 7 Volts 0.02 mA at 0.8 Volts

Description	Min	Typ	Max	Units
Frequency Range	DC		20	GHz
Impedance		50		Ohms
Operating Voltage	20	24	32	Volts
Actuating Current @ 24 Volts		68		mA
Switching Time			15	ms
Coil Resistance		350		Ohms
Third Order Intermodulation		-120		dBc
Input Power (CW)			1	Watts

Performance by Frequency

Description	F1	F2	F3	F4	F5	Units
Frequency Range	DC - 6	6 - 12.4	12.4 - 20			GHz
VSWR, Max	1.15:1	1.25:1	1.3:1			
Insertion Loss, Max	0.3	0.4	0.5			dB
Isolation, Min	85	75	65			dB

Electrical Specification Notes:
Insertion Loss Repeatability at 25° is 0.03 dB



Features:

- DC to 20 GHz SPDT Switch
- Guaranteed Low Insertion loss
Repeatability: 0.03 dB max over 10 Million Lifecycles
- Insertion Loss: 0.5 dB max
- Isolation: up to 65 dB min
- +24 Vdc Nominal Voltage
- Hot Switching: 1W CW max
- Latching Self Cutoff Actuator
- TTL Logic Control
- Position Indicators
- Guaranteed to meet MIL-STD-202 Environmental Conditions
- SMA connectors
- -25°C to +75°C Operating Temperature
- 10 Million Lifecycles Minimum

Applications:

- Electronic Warfare
- Electronic Countermeasures
- Microwave Radio
- VSAT
- Radar
- Space Systems
- Test Instrumentation
- Research and Development
- Signal Monitoring Devices

Fairview Microwave
1130 Junction Dr. #100
Allen, TX 75013
Tel: 1-800-715-4396 / (972) 649-6678
Fax: (972) 649-6689
www.fairviewmicrowave.com
sales@fairviewmicrowave.com

Mechanical Specifications

Size

Length	1.25 in [31.75 mm]
Width/Diameter	1.25 in [31.75 mm]
Height	0.5 in [12.7 mm]
Weight	0.1085 lbs [49.21 g]
Body Material and Plating	Aluminum, Nickel
Package Type	Connectorized
Operating Life	10,000,000 Cycles

Connectors

RF Connector Type	SMA Female
RF Connector Contact Material & Plating	Beryllium Copper, Gold
RF Connector Body Material & Plating	Passivated Stainless Steel
Control Connector	Solder Pin

Environmental Specifications

Temperature

Operating Range	-25 to +75 deg C
Storage Range	-55 to +85 deg C

Humidity	15 to 95% relative humidity
Shock	50g / 11 ms, sawtooth
Sine Vibration	10-2000 Hz, 20g
Random Vibration	16.91g (rms) 50-2000 Hz, 3 min/axis
Altitude	15000 ft
Temperature Cycling	-55 to +85 (10 Cycles)
ESD Sensitivity	ESD Sensitive Material, Transport material in Approved ESD bags. Handle only in ESD Workstation.



Compliance Certifications (see [product page](#) for current document)

Plotted and Other Data

Notes:

Typical Performance Data

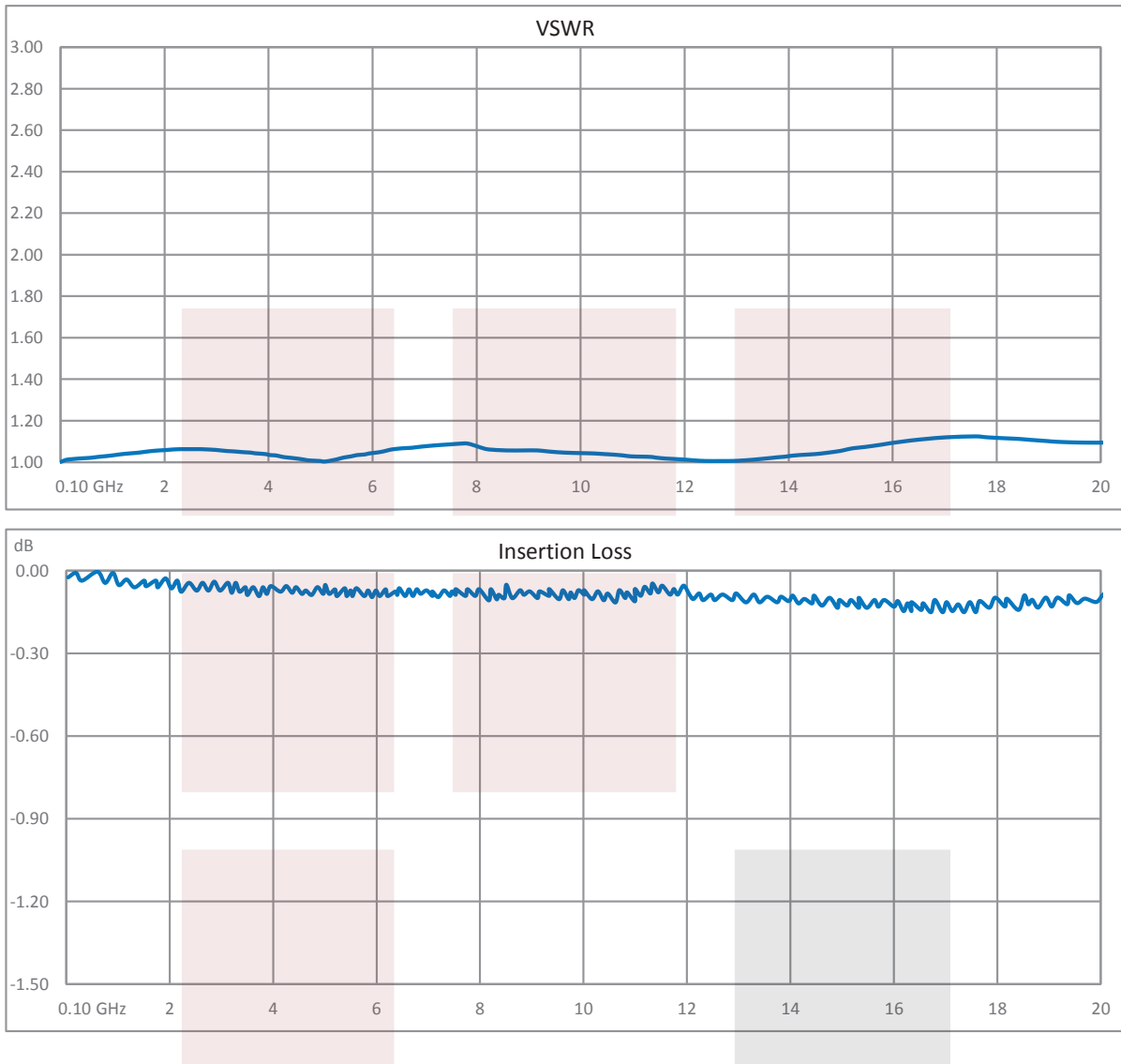

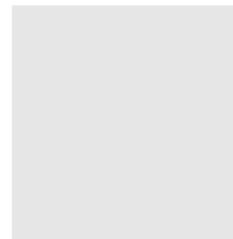
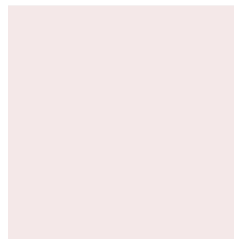
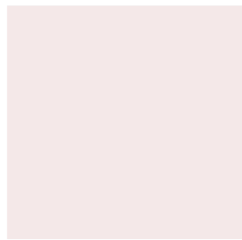
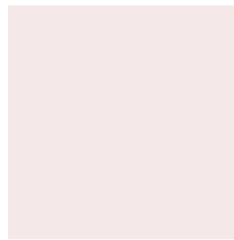
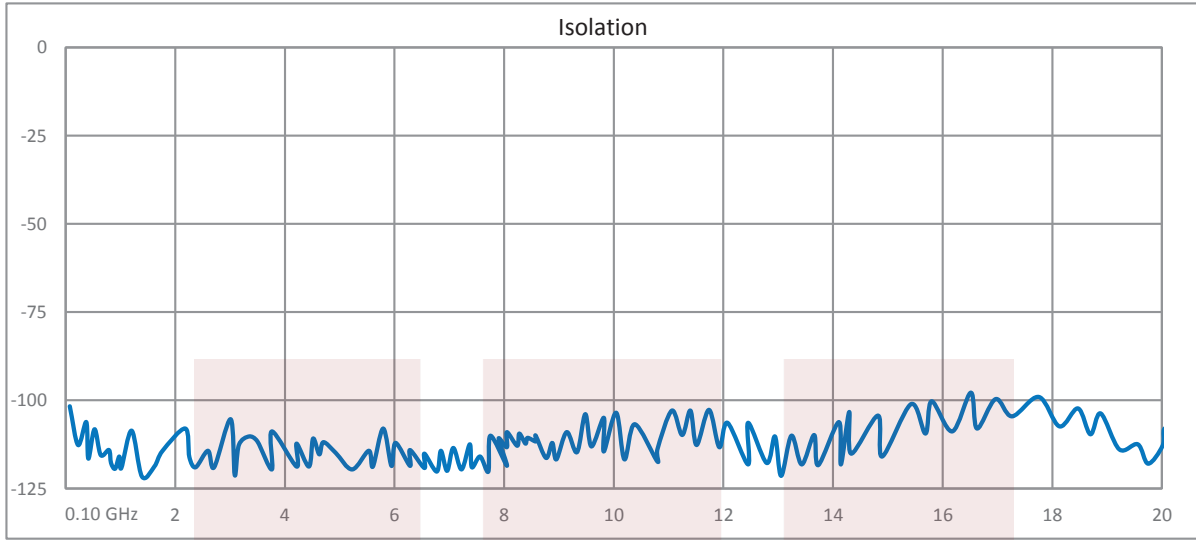

POWER RATING CHART

This graph is based on the following conditions :

- Ambient temperature : + 25°C
- Sea level
- V.S.W.R. : 1 and cold switching

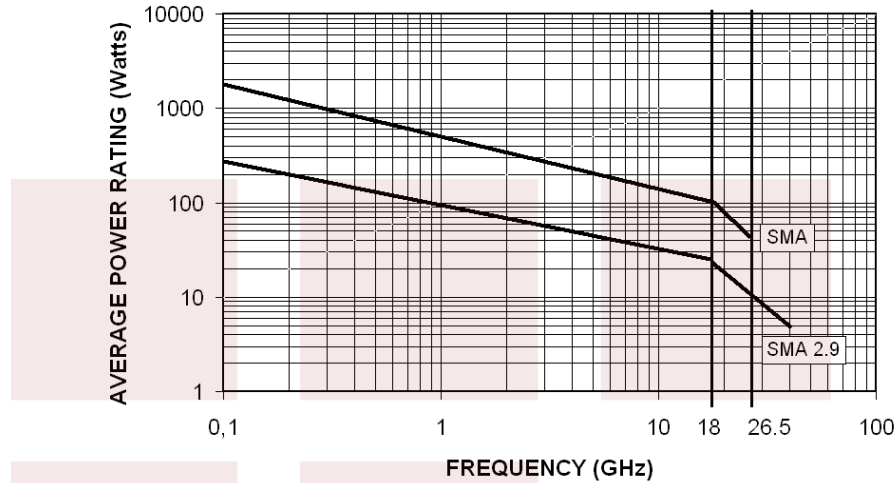

DERATING FACTOR VERSUS V.S.W.R.

The average power input must be reduced for load V.S.W.R. above 1.

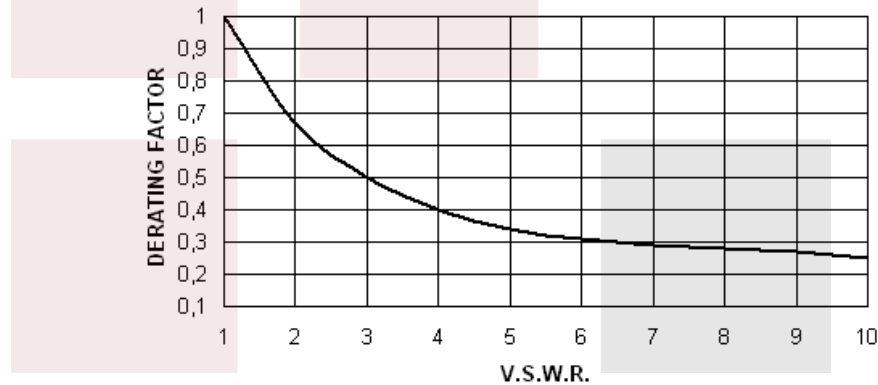

SPDT Latching 0.03 dB Low Insertion Loss Repeatability DC to 20 GHz Relay Switch, Indicators, Self Cut Off, TTL, 1W, 24V, SMA from Fairview Microwave is in-stock and available to ship same-day. All of our RF/microwave products are available off-the-shelf from our ISO 9001:2008 certified facilities in Allen, Texas. Fairview Microwave is RF on-demand.

For additional information on this product, please click the following link: [SPDT Latching 0.03 dB Low Insertion Loss Repeatability DC to 20 GHz Relay Switch, Indicators, Self Cut Off, TTL, 1W, 24V, SMA FMSW6336](#)

URL: <https://www.fairviewmicrowave.com/spdt-latching-electromechanical-relay-switch-indicators-ttl-fmsw6336-p.aspx>

The information contained in this document is accurate to the best of our knowledge and representative of the part described herein. It may be necessary to make modifications to the part and/or the documentation of the part, in order to implement improvements. Fairview Microwave reserves the right to make such changes as required. Unless otherwise stated, all specifications are nominal. Fairview Microwave does not make any representation or warranty regarding the suitability of the part described herein for any particular purpose, and Fairview Microwave does not assume any liability arising out of the use of any part or documentation.

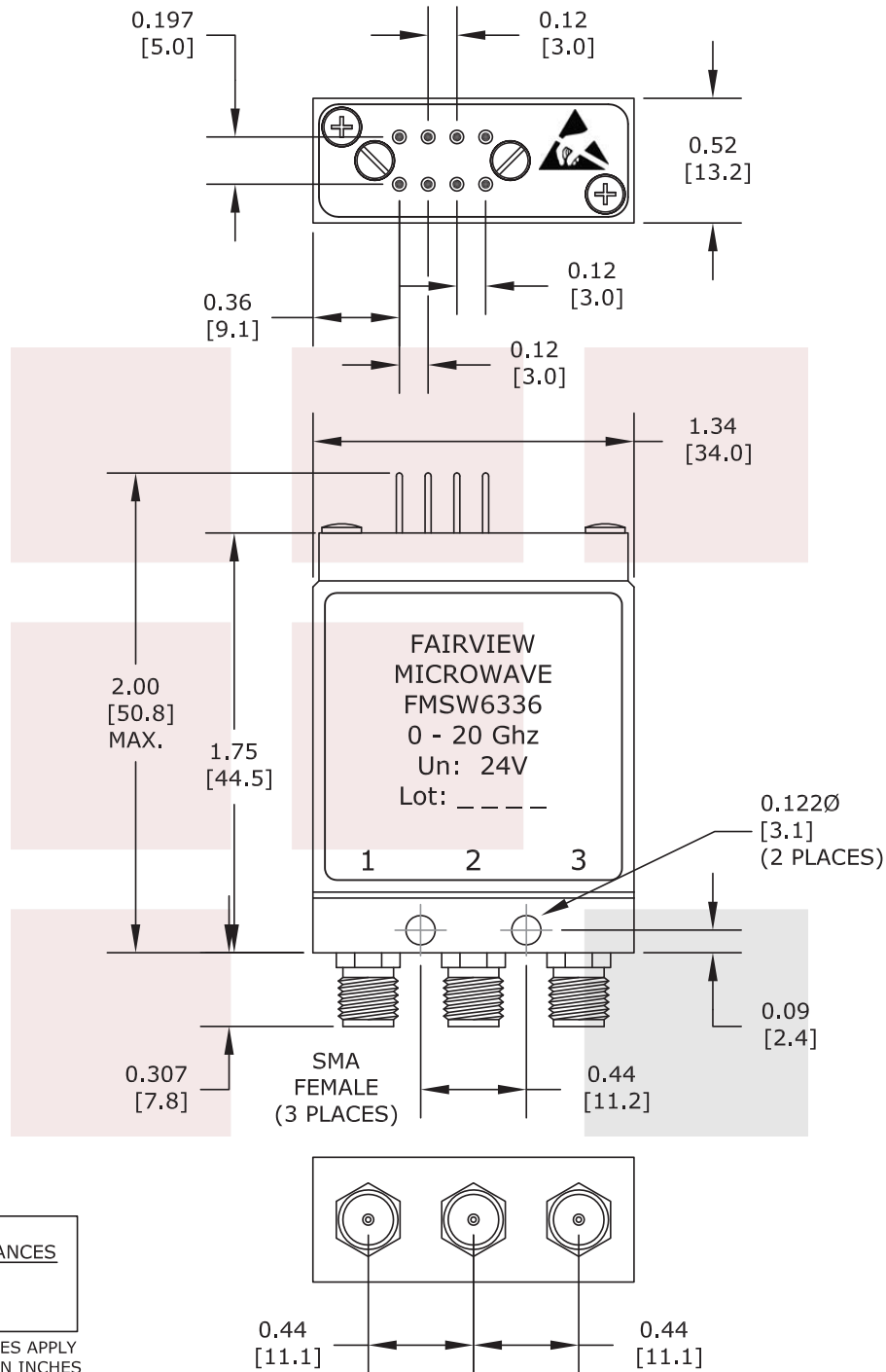

STANDARD TOLERANCES
DECIMAL
±0.02

*STANDARD TOLERANCES APPLY ONLY TO DIMENSIONS IN INCHES

FAIRVIEW MICROWAVE INC.		NOTES: 1. UNLESS OTHERWISE SPECIFIED ALL DIMENSIONS ARE NOMINAL. 2. ALL SPECIFICATIONS ARE SUBJECT TO CHANGE WITHOUT NOTICE AT ANY TIME. 3. DIMENSIONS ARE IN INCHES [mm].			
ALLEN, TX 75013 WWW.FAIRVIEWMICROWAVE.COM		DWG NO FMSW6336		CAGE CODE 3FKR5	
TITLE SPDT Latching 0.03 dB Low Insertion Loss Repeatability DC to 20 GHz Relay Switch, Indicators, Self Cut Off, TTL, 1W, 24V, SMA		CAD FILE 030117	SHEET	SCALE N/A	SIZE A
				2233	

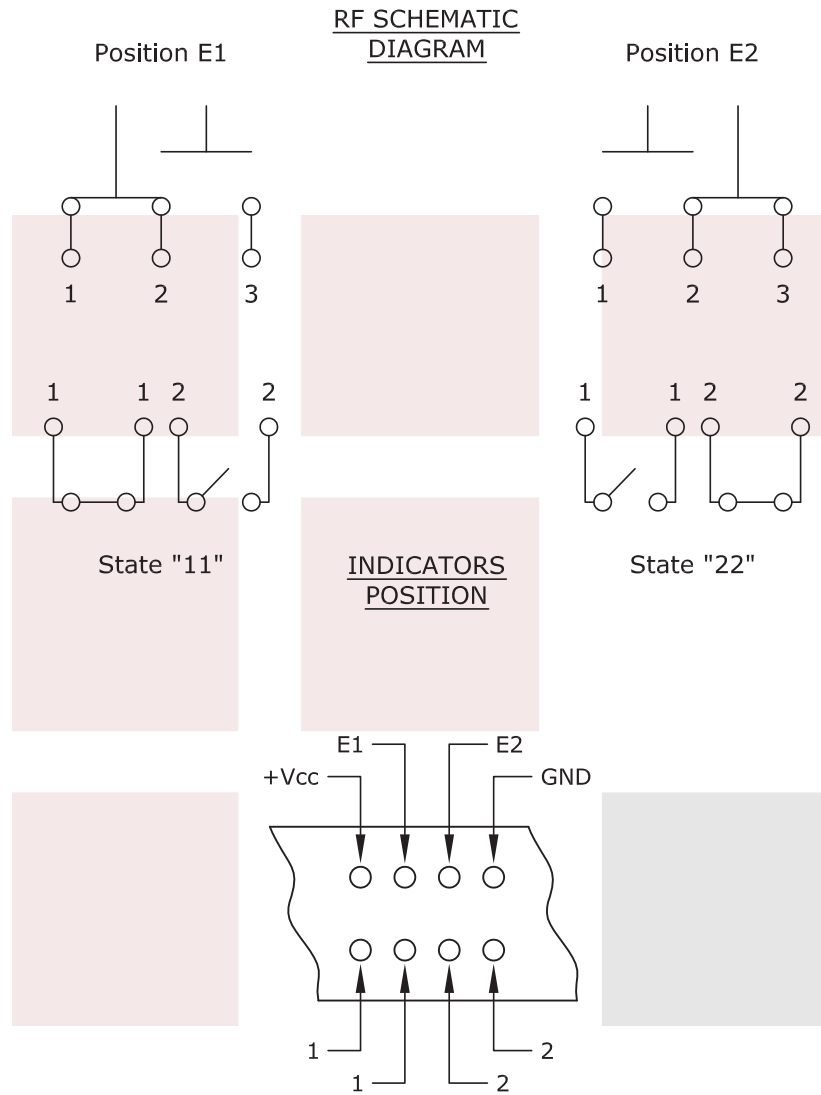

TTL drive option "2"

- Connect pin GND to ground.
- Connect pin +Vcc to supply
- Select (close) desired RF path by applying TTL "High" to the corresponding "drive" pin
(Ex: apply TTL "High" to pin E1 to switch to position E1. RF path 1-2 closed and RF path 2-3 open).
- To open desired path and close the new RF path, apply TTL "High" to the "drive" pin which corresponds to the desired RF path. (Ex: apply TTL "High" to pin E2 to open RF path 1-2 and close RF path 2-3).

STANDARD TOLERANCES
DECIMAL
±0.02

*STANDARD TOLERANCES APPLY ONLY TO DIMENSIONS IN INCHES

FAIRVIEW MICROWAVE INC. ALLEN, TX 75013 WWW.FAIRVIEWMICROWAVE.COM		NOTES: 1. UNLESS OTHERWISE SPECIFIED ALL DIMENSIONS ARE NOMINAL. 2. ALL SPECIFICATIONS ARE SUBJECT TO CHANGE WITHOUT NOTICE AT ANY TIME. 3. DIMENSIONS ARE IN INCHES [mm].		
TITLE SPDT Latching 0.03 dB Low Insertion Loss Repeatability DC to 20 GHz Relay Switch, Indicators, Self Cut Off, TTL, 1W, 24V, SMA		DWG NO FMSW6336	CAGE CODE 3FKR5	
CAD FILE	030117	SHEET	SCALE	N/A
SIZE	A	2233		