

**SPDT High Isolation PIN Diode Switch DC to 18 GHz,
65 dB, 27 dBm, 3 dB Loss and SMA**

FMSW5005 is a Single Pole Double Throw (SPDT) Absorptive Switch that covers a wide frequency band from DC to 18 GHz. This general purpose design utilizes GaAs MESFET MMIC technology that has extremely fast switching speed levels of 12 nsec. Additional typical performance includes 65 dB Isolation up to 6 GHz, and 2 dB Insertion Loss at 10 GHz.

The design also incorporates CMOS driver circuitry that allows a single +5V biased voltage at very low DC current levels. The drop-in package is hermetically sealed with field replaceable SMA connectors. Operating temperature range is -55°C to +85°C. And for added confidence, this rugged package assembly is designed to meet MIL-STD-883 test conditions for Hermeticity and Temperature Cycle.

This High Isolation PIN Diode Switch is part of Fairview Microwave's expanding line of PIN Diode Switch offerings. These parts offer high isolation performance in a very wide Frequency Range coverage and outstanding electrical performance in the band.

Electrical Specifications

Description	Min	Typ	Max	Units
Frequency Range	DC		18	GHz
Insertion Loss		3		dB
Isolation		65		dB
Switching Speed		12		ns
Control Input		TTL		
Power Handling		+27		dBm



Features:

- SPDT Absorptive Switch Design
- GaAs MESFET MMIC Technology
- Ultra Fast Switching Speed 12 nsec typical
- High Isolation 65 dB typical up to 6 GHz
- Low Insertion Loss 2 dB typical at 10 GHz
- CMOS Driver Circuit
- Hermetically Sealed Module
- Field Replaceable SMA Connectors
- -55°C to +85°C Operating Temperature
- Designed to meet MIL-STD-883 Conditions

Applications:

- Electronic Warfare
- Electronic Countermeasures
- Microwave Radio
- VSAT
- Radar
- Fiber Optic
- Space Systems
- Test Instrumentation
- Telecom Infrastructure
- Base station Infrastructure

Fairview Microwave
1130 Junction Dr. #100
Allen, TX 75013
Tel: 1-800-715-4396 / (972) 649-6678
Fax: (972) 649-6689
www.fairviewmicrowave.com
sales@fairviewmicrowave.com

Performance by Frequency

Parameter	Frequency	Min.	Typ.	Max.	Units
Insertion Loss	DC - 6 GHz		1.6	2.4	dB
	DC - 10 GHz		2.0	2.8	dB
	DC - 18 GHz		3.0	5.5	dB
Isolation	DC - 6 GHz	55	65		dB
	DC - 10 GHz	50	60		dB
	DC - 18 GHz	42	55		dB
Return Loss	DC - 6 GHz		17		dB
	DC - 18 GHz		12		dB
Return Loss RF1, RF2	DC - 6 GHz		14		dB
	DC - 18 GHz		17		dB
Input Power for 1 dB Compression	0.5 - 18 GHz	24	27		dBm
Input Third Order Intercept (Two-Tone Input Power = +7 dBm Each Tone)	0.5 - 18 GHz		46		dBm
Switching Characteristics tRISE, tFALL (10/90% RF)	DC - 18 GHz		3		ns
		tON, tOFF (50% CTL to 10/90% RF)		12	
Switching Transients	DC - 18 GHz		12		mVpp

Functional Block Diagram

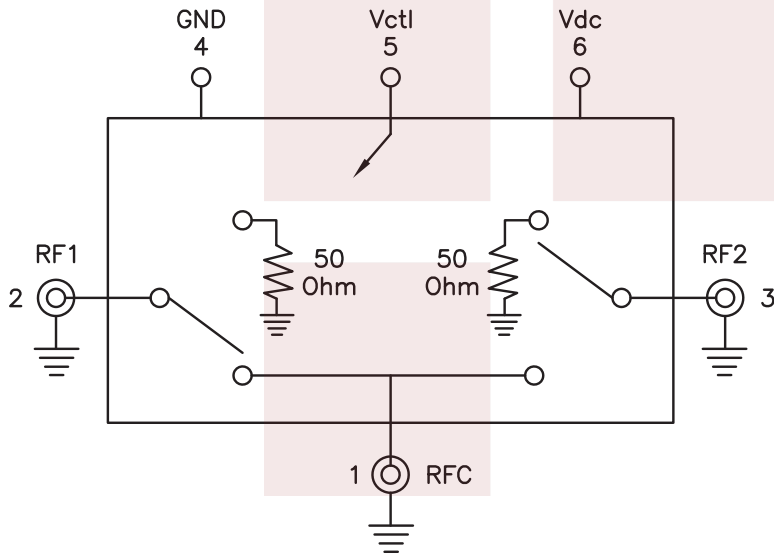

Mechanical Specifications

Size

Length	0.9 in [22.86 mm]
Width/Dia.	0.8 in [20.32 mm]
Height	0.355 in [9.02 mm]
Weight	0.1034 lbs [46.9 g]

Environmental Specifications By Design

Temperature

Operating Range	-55 to +85 deg C
Storage Range	-65 to +150 deg C

Temperature Cycling
 Hermetic Seal

MIL-STD-883, Method 101C, Cond B

Gross Leak MIL-STD-883 Method 1014C1/Fine Leak MIL-STD-883, Method 1014A2, 5 x 10⁻⁸ atm cc

ESD Sensitivity

ESD Sensitive Material, Transport material in Approved ESD bags. Handle only in ESD Workstation.



Compliance Certifications (visit www.FairviewMicrowave.com for current document)

RoHS Compliant

Plotted and Other Data

Notes:

- Values at +25 °C, sea level

Typical Performance Data

Insertion Loss

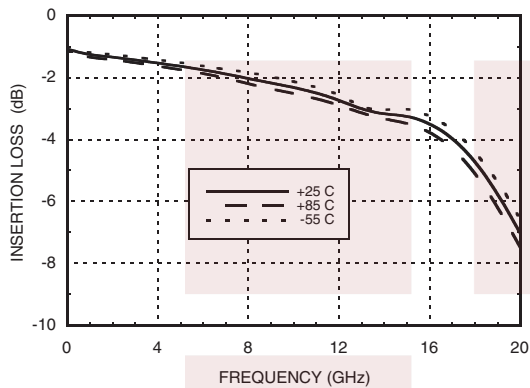

Return Loss RFC

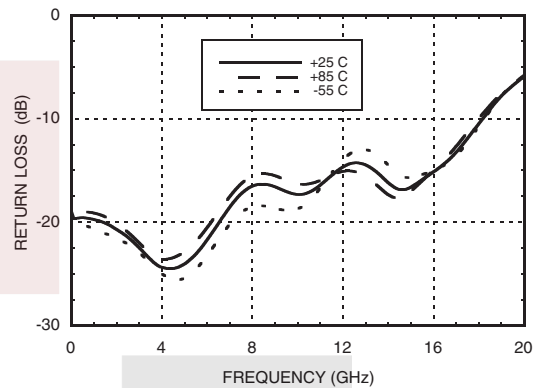

Return Loss RF1, RF2 On

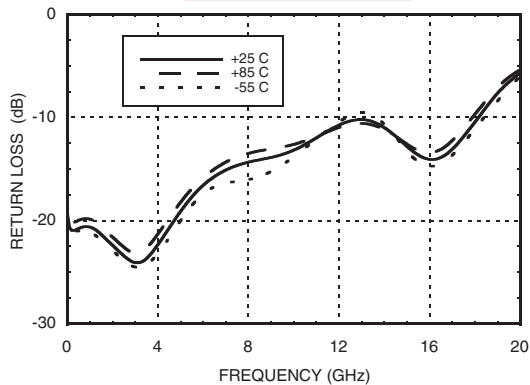

Return Loss RF1, RF2 Off

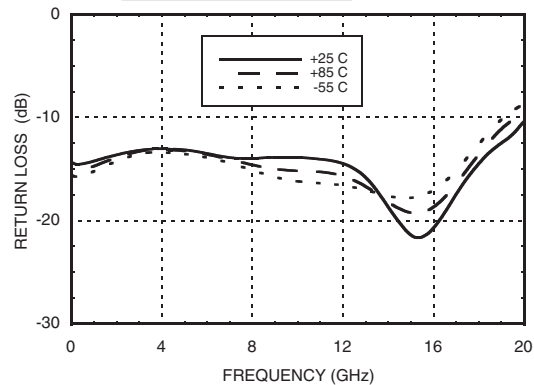

Isolations

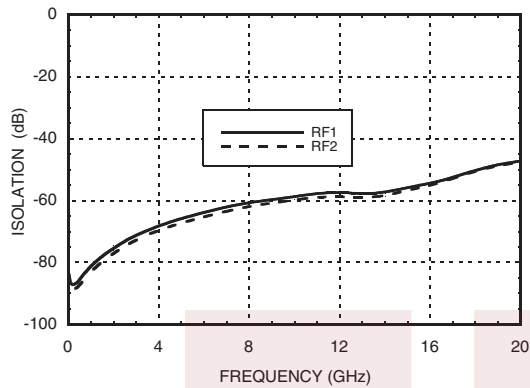

Isolation Between Ports RF1 and RF2

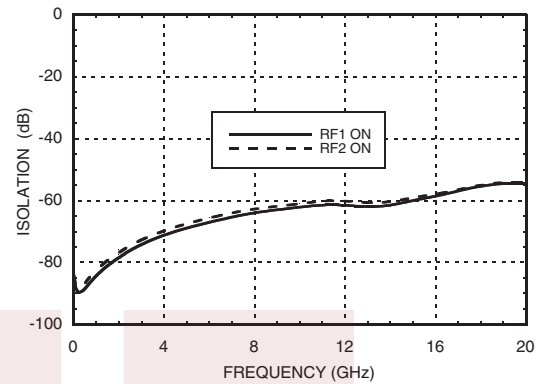

Input P1dB Compression Point

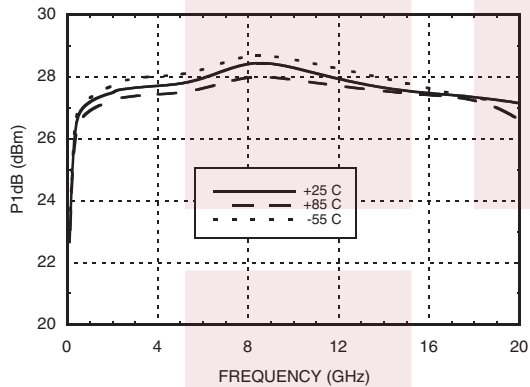

Input Third Order Intercept Point

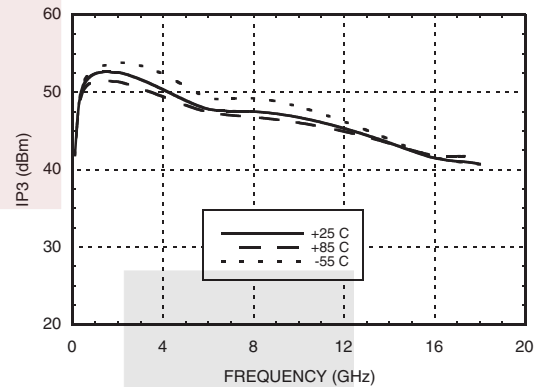

SPDT High Isolation PIN Diode Switch DC to 18 GHz, 65 dB, 27 dBm, 3 dB Loss and SMA from Fairview Microwave is in-stock and available to ship same-day. All of our RF/microwave products are available off-the-shelf from our ISO 9001:2008 certified facilities in Allen, Texas. Fairview Microwave is RF on-demand.

For additional information on this product, please click the following link: [SPDT High Isolation PIN Diode Switch DC to 18 GHz, 65 dB, 27 dBm, 3 dB Loss and SMA FMSW5005](#)

URL: <https://www.fairviewmicrowave.com/high-isolation-pin-diode-switch-18-ghz-65db-3db-fmsw5005-p.aspx>

The information contained in this document is accurate to the best of our knowledge and representative of the part described herein. It may be necessary to make modifications to the part and/or the documentation of the part, in order to implement improvements. Fairview Microwave reserves the right to make such changes as required. Unless otherwise stated, all specifications are nominal. Fairview Microwave does not make any representation or warranty regarding the suitability of the part described herein for any particular purpose, and Fairview Microwave does not assume any liability arising out of the use of any part or documentation.

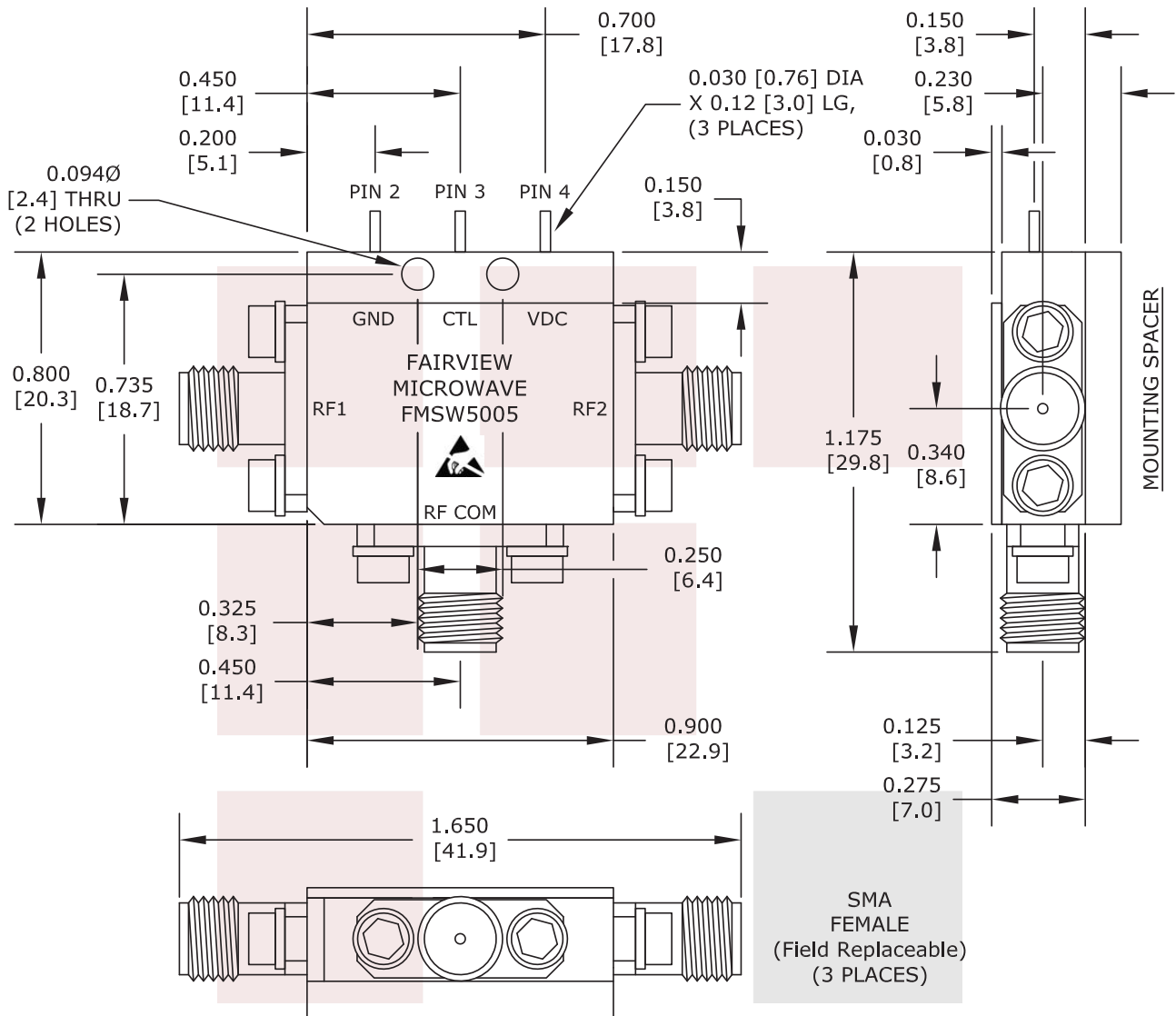

TRUTH TABLE		
CONTROL INPUT	SIGNAL PATH STATE	
	Vctl	RFC to RF1
HIGH	ON	OFF
LOW	OFF	ON

FAIRVIEW MICROWAVE INC.
ALLEN, TX 75013 WWW.FAIRVIEWMICROWAVE.COM

NOTES:
1. UNLESS OTHERWISE SPECIFIED ALL DIMENSIONS ARE NOMINAL.
2. ALL SPECIFICATIONS ARE SUBJECT TO CHANGE WITHOUT NOTICE AT ANY TIME.
3. DIMENSIONS ARE IN INCHES [mm].

TITLE
SPDT High Isolation PIN Diode Switch DC to 18 GHz,
65 dB, 27 dBm, 3 dB Loss and SMA

DWG NO FMSW5005 CAGE CODE 3FKR5

CAD FILE 071916 SHEET SCALE N/A SIZE A 2233