

N Male to N Male Cable RG-316 Coax in 24 Inch

Electrical Specifications

Description	Min	Typ	Max	Units
Frequency Range	DC		3	GHz
VSWR			1.35:1	
Velocity of Propagation		70		%
Capacitance		32 [104.99]		pF/ft [pF/m]

Mechanical Specifications

Cable Assembly

Length 24 in [609.6 mm]

Cable

Cable Type RG-316
 Impedance 50 Ohms
 Inner Conductor Type Solid
 Inner Conductor Material and Plating Copper, Silver
 Dielectric Type PTFE
 Number of Shields 1
 Shield Layer 1 Silver Plated Copper Braid
 Jacket Material FEP, Tan
 Jacket Diameter 0.098 in [2.49 mm]

Connectors

Description	Connector 1	Connector 2
Type	N Male	N Male
Impedance	50 Ohms	50 Ohms
Configuration	Straight	Straight
Contact Material & Plating	Beryllium Copper, Gold	Beryllium Copper, Gold
Dielectric Type	PTFE	PTFE
Body Material & Plating	Brass, Nickel	

Environmental Specifications

Temperature

Operating Range -55 to +125 deg C

Compliance Certifications (visit www.FairviewMicrowave.com for current document)

Plotted and Other Data

Notes:



Configuration:

- N Male
- N Male
- RG-316

Fairview Microwave
 1130 Junction Dr. #100
 Allen, TX 75013
 Tel: 1-800-715-4396 / (972) 649-6678
 Fax: (972) 649-6689
www.fairviewmicrowave.com
sales@fairviewmicrowave.com

Typical Performance Data

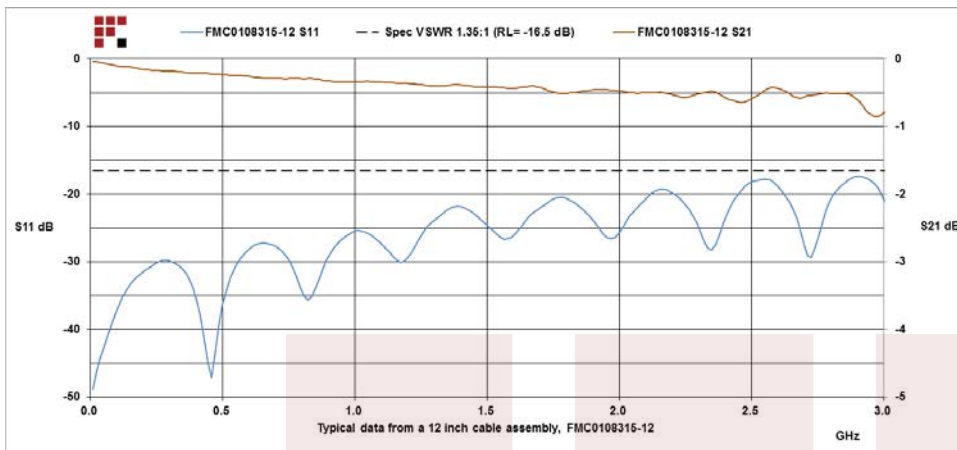

How to Order

Part Number Configuration:

FMC0108315 - xx uu

cm = Centimeters
 <blank> = Inches
 Length

Example: FMC0108315-12 = 12 inches long cable
 FMC0108315-100cm = 100 cm long cable

N Male to N Male Cable RG-316 Coax in 24 Inch from Fairview Microwave has same day shipment for domestic and International orders. Our RF, microwave and fiber optic products maintain a 99% availability and are part of the broadest selection in the industry.

Click the following link to obtain additional part information: [N Male to N Male Cable RG-316 Coax in 24 Inch FMC0108315-24](#)

URL: <http://www.fairviewmicrowave.com/standard-n-male-n-male-cable-rg316-coax-fmc0108315-24-p.aspx>

The information contained in this document is accurate to the best of our knowledge and representative of the part described herein. It may be necessary to make modifications to the part and/or the documentation of the part, in order to implement improvements. Fairview Microwave reserves the right to make such changes as required. Unless otherwise stated, all specifications are nominal. Fairview Microwave does not make any representation or warranty regarding the suitability of the part described herein for any particular purpose, and Fairview Microwave does not assume any liability arising out of the use of any part or documentation.

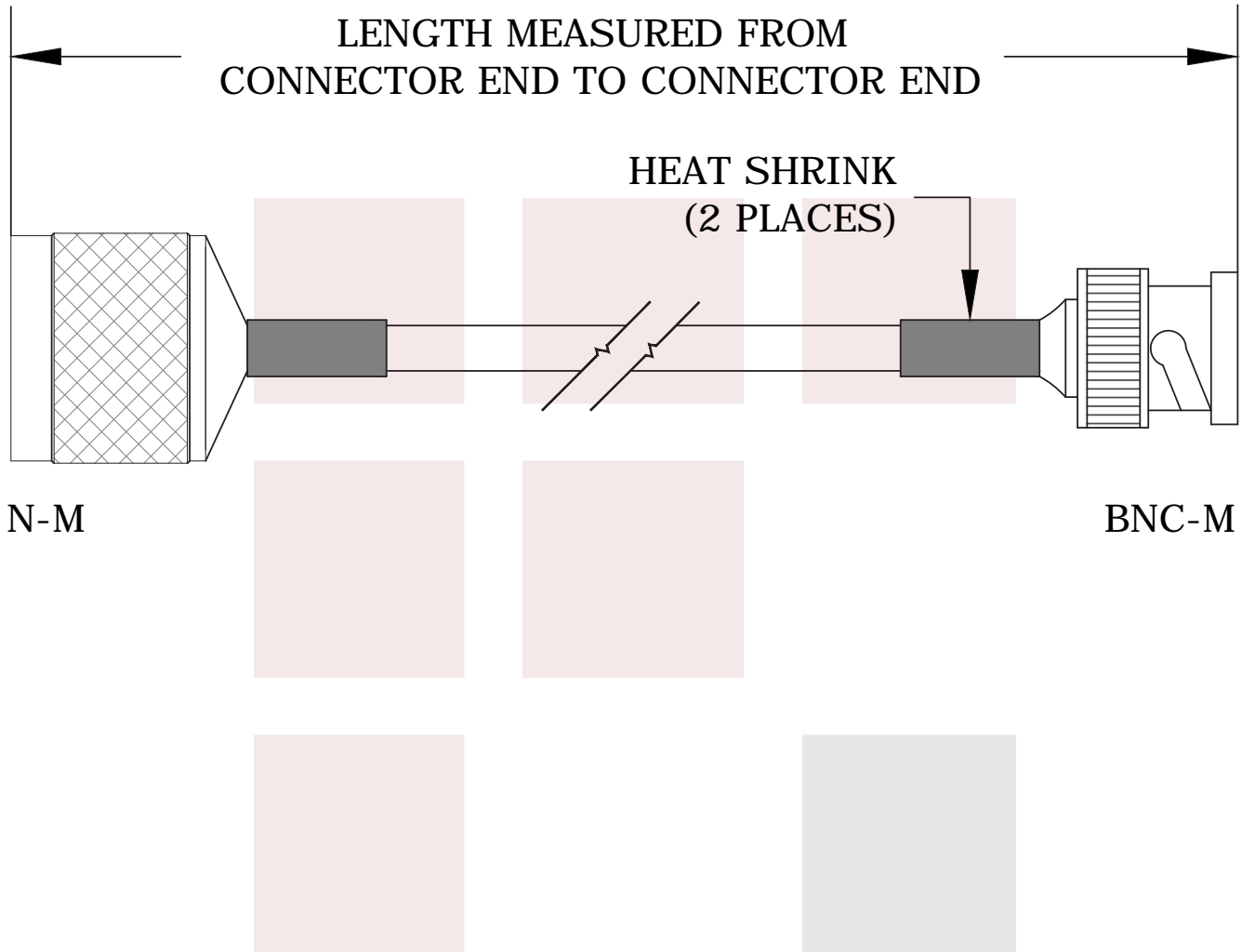

FAIRVIEW MICROWAVE INC.
 ALLEN, TX 75013 WWW.FAIRVIEWMICROWAVE.COM

NOTES:
 1. UNLESS OTHERWISE SPECIFIED ALL DIMENSIONS ARE NOMINAL.
 2. ALL SPECIFICATIONS ARE SUBJECT TO CHANGE WITHOUT NOTICE AT ANY TIME.
 3. DIMENSIONS ARE IN INCHES [mm].

TITLE	DWG NO		CAGE CODE	
	FMC0101315		3FKR5	
	CAD FILE	SHEET	SCALE	SIZE
	022506		N/A	A
				5568

N Male to N Male Cable RG-316 Coax in 24 Inch