

STANDARD TOLERANCES

.X ±0.2

.XX ±0.01

.XXX ±0.005

*STANDARD TOLERANCES APPLY ONLY TO DIMENSIONS IN INCHES

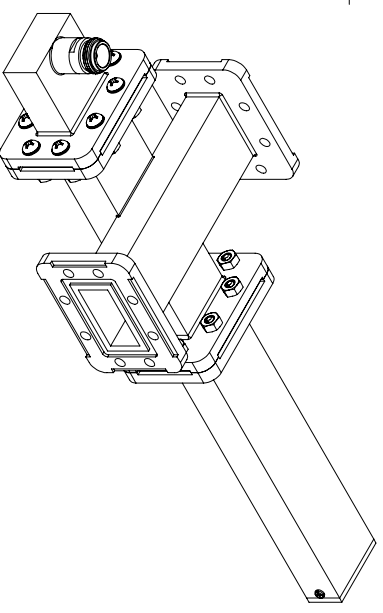

FAIRVIEW MICROWAVE INC.

ALLEN, TX 75013 WWW.FAIRVIEWMICROWAVE.COM

NOTES:
1. UNLESS OTHERWISE SPECIFIED ALL DIMENSIONS ARE NOMINAL.
2. ALL SPECIFICATIONS ARE SUBJECT TO CHANGE WITHOUT NOTICE AT ANY TIME.
3. DIMENSIONS ARE IN INCHES [mm].

TITLE		DWG NO		CAGE CODE	
		FMWCT1113		3FKR5	
CAD FILE	062817	SHEET	1 OF 1	SCALE	N/A
		SIZE	A		9999