

6

5

4

3

2

1

REVISION

ZONE	REV	DESCRIPTION	DATE	CHANGED BY	APPROVED
	A	INITIAL RELEASE	11/27/2023	DMAY	SPONG

F

F

E

E

D

D

C

C

B

B

A

A

Ø 1.78 [45]

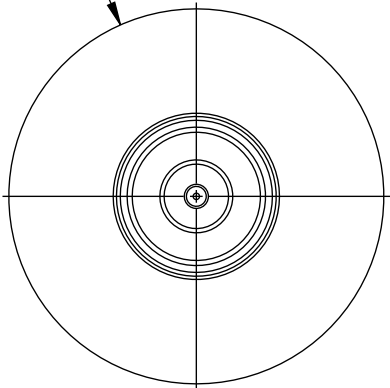

N-TYPE MALE

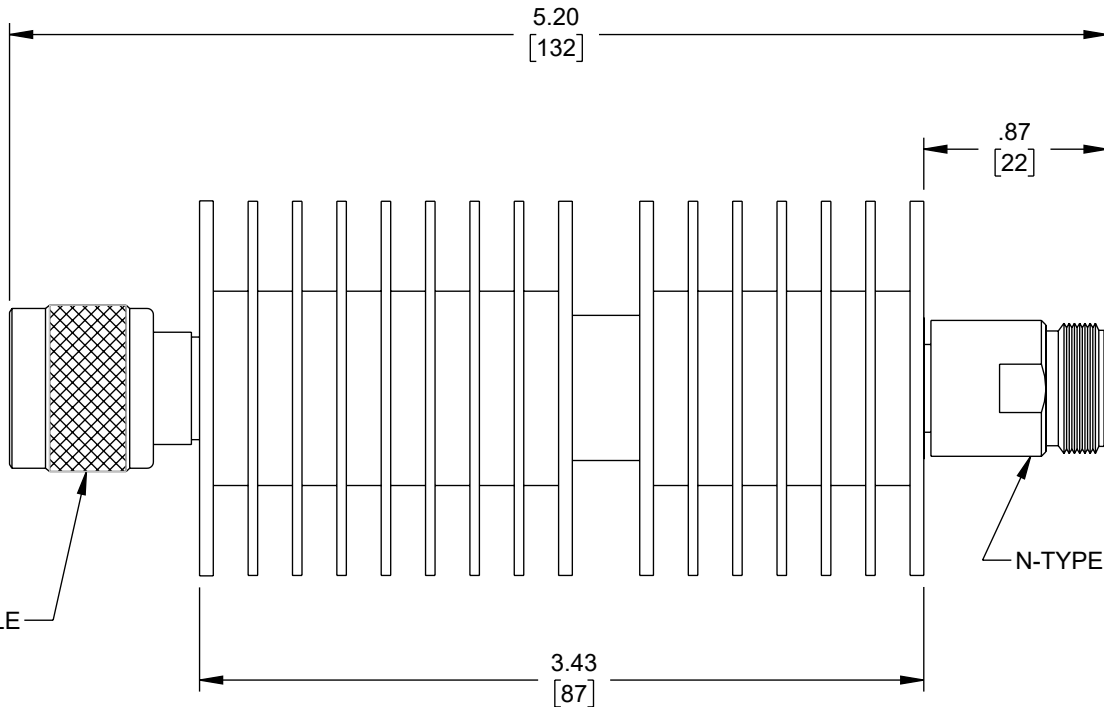

N-TYPE FEMALE

UNLESS OTHERWISE SPECIFIED  
LEADING DIMENSIONS ARE INCHES  
DIMENSIONS IN [ ] ARE MILLIMETERS

TOLERANCES:

X = ±.2 [5]	FRACTIONS
XX = ±.02 [0.5]	± 1/32
.XXX = ±.005 [0.13]	ANGLES ± 1°

CABLE LENGTH TOLERANCES:

≤12 [305]	= +1 [25] / -0
>12 [305] ≤ 60 [1524]	= +2 [51] / -0
>60 [1524] ≤ 120 [3048]	= +4 [102] / -0
>120 [3048] ≤ 300 [7620]	= +6 [152] / -0
>300 [7620]	= +5% / -0

ALL DIMENSIONS ARE FOR REFERENCE ONLY  
AND SUBJECT TO CHANGE WITHOUT NOTICE  
UN-DIMENSIONED/NON-CRITICAL FEATURES  
MAY VARY IN SIZE AND LOCATION  
COLORS MAY VARY



Website: [www.FairviewMicrowave.com](http://www.FairviewMicrowave.com)  
Phone: 1.800.715.4396 | 1.972.649.6678

INTERPRET ALL DIMENSIONS AND TOLERANCES PER ASME Y14.5	
SCALE	SHEET
NONE	1 OF 1

DESCRIPTION  
**40dB RF FIXED ATTENUATOR 50W, DC TO 18GHz, N-TYPE MALE TO N-TYPE FEMALE**

THE INFORMATION CONTAINED IN THIS DRAWING IS THE SOLE PROPERTY OF INFINITE ELECTRONICS, INC. ANY REPRODUCTION IN PART OR WHOLE WITHOUT THE WRITTEN PERMISSION OF INFINITE ELECTRONICS, INC. IS PROHIBITED. THESE COMMODITIES, TECHNOLOGY OR SOFTWARE WERE EXPORTED FROM THE UNITED STATES IN ACCORDANCE WITH THE EXPORT ADMINISTRATION REGULATIONS. DIVERSION CONTRARY TO U.S. LAW PROHIBITED.

SIZE	CAGE CODE	DRAWN BY	ITEM NO.	REV
A	3FKR5	DMAY	FMAT7604-40	A

6

5

4

3

2

1