

SMA Female Connector Field Replaceable Attachment 2 Hole Flange 0.015 inch Pin, .355 inch Hole Spacing with Metal Contact Ring

SMA female 2 hole flange mount field replaceable connector with EMI gasket, part number FMCN1624, from Fairview Microwave is in-stock and ships same day. This SMA female connector operates up to a maximum frequency of 27 GHz and offers excellent VSWR of 1.2:1. Fairview's FMCN1624 2 hole flange SMA connector enables designers to make external connections on product enclosures, and can be used in a variety of other rack mount and panel mount applications. Fairview's field replaceable connector is easy to install or replace in the field.

Fairview's SMA female 2 hole flange connector FMCN1624 datasheet specifications and outline drawing are shown in this PDF below. Our extensive offering of RF, microwave and millimeter wave connectors allows designers to configure and customize their signal connections however they like. From providing an I/O for a board design to creating a custom cable assembly configuration, Fairview Microwave has a connector solution to meet your needs. Fairview Microwave also has the expertise to build your custom cable assemblies for you and ship them same-day.

Electrical Specifications

Description	Min	Typ	Max	Units
Frequency Range	DC		27	GHz
VSWR			1.2:1	

Mechanical Specifications

Size	
Length	0.372 in [9.45 mm]
Width/Dia.	0.25 in [6.35 mm]
Height	0.5 in [12.7 mm]
Weight	1.7 lbs [771.11 g]
Mating Cycles	500 Cycles

Material Specifications

Description	Material	Plating
Contact	Beryllium Copper	Gold
Insulation	PTFE	
Outer Conductor	Passivated Stainless Steel	
Body	Passivated Stainless Steel	

Environmental Specifications

Temperature	
Operating Range	-65 to +165 deg C

Compliance Certifications (see [product page](#) for current document)

Plotted and Other Data

Notes:



Configuration:

- SMA Female Connector
- Straight Body Geometry
- 0.015 inch Pin Interface Type
- Field Replaceable Attachment
- 2 Hole Flange

Features:

- Operating Frequency of 27 GHz Max.
- Excellent VSWR of 1.2:1
- Gold Plated Beryllium Copper Contact
- Metal Contact Ring

Applications:

- General Purpose Test
- Rack and Panel Mount Applications
- Used in Product Requiring Hermetic Seals
- Allows for Replacement of Damaged Connectors

Fairview Microwave
301 Leora Ln., Suite 100
Lewisville, TX 75056
Tel: 1-800-715-4396 / (972) 649-6678
Fax: (972) 649-6689
www.fairviewmicrowave.com
sales@fairviewmicrowave.com

SMA Female Connector Field Replaceable Attachment 2 Hole Flange 0.015 inch Pin, .355 inch Hole Spacing with Metal Contact Ring from Fairview Microwave is in-stock and available to ship same-day. All of our RF/microwave products are available off-the-shelf from our ISO 9001:2008 certified facilities in Lewisville, Texas. Fairview Microwave is RF on-demand.

For additional information on this product, please click the following link: [SMA Female Connector Field Replaceable Attachment 2 Hole Flange 0.015 inch Pin, .355 inch Hole Spacing with Metal Contact Ring FMCN1624](#)

URL: <https://www.fairviewmicrowave.com/sma-female-0.015-pin-connector-fmcn1624-p.aspx>

The information contained in this document is accurate to the best of our knowledge and representative of the part described herein. It may be necessary to make modifications to the part and/or the documentation of the part, in order to implement improvements. Fairview Microwave reserves the right to make such changes as required. Unless otherwise stated, all specifications are nominal. Fairview Microwave does not make any representation or warranty regarding the suitability of the part described herein for any particular purpose, and Fairview Microwave does not assume any liability arising out of the use of any part or documentation.



REVISIONS			
REV.	DESCRIPTION	DATE	APPROVED
A	INITIAL RELEASE	3/30/2020	S.ELLIS

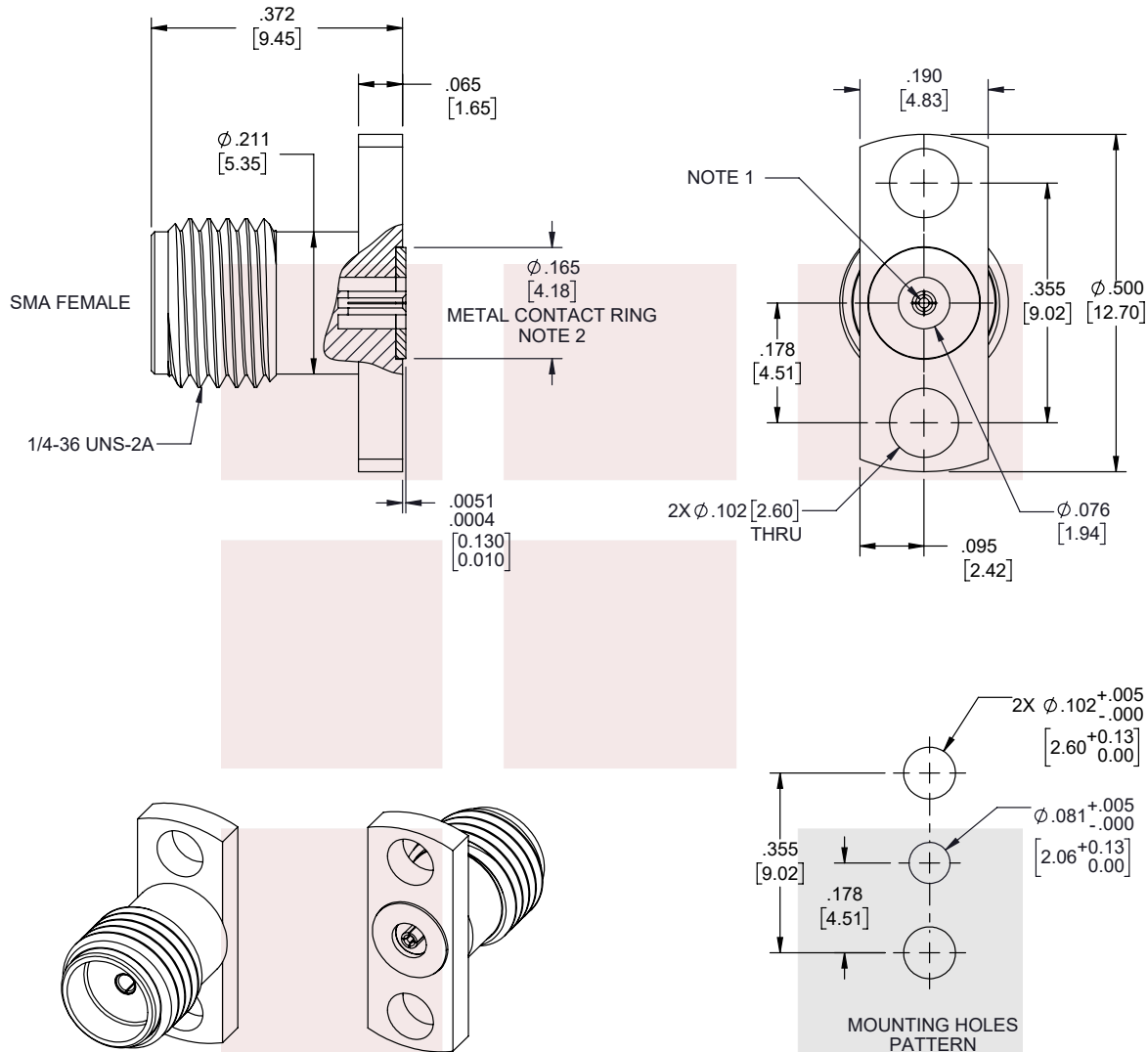

NOTES:

1. FEMALE CONTACT ACCEPTS PIN SIZE $\phi .015$ [0.38] $\nabla .100$ [2.55] MAX.
2. SEPARATE METAL CONTACT RING (PASSIVATED).

THESE COMMODITIES, TECHNOLOGY OR SOFTWARE WERE EXPORTED FROM THE UNITED STATES IN ACCORDANCE WITH THE EXPORT ADMINISTRATION REGULATIONS. DIVERSION CONTRARY TO U.S. LAW PROHIBITED.



TITLE
SMA Female Connector Field Replaceable Attachment
2 Hole Flange 0.015 inch Pin, .355 inch Hole Spacing
with Metal Contact Ring

UNLESS OTHERWISE SPECIFIED LEADING DIMENSIONS ARE INCHES
DIMENSIONS IN [] ARE MILLIMETERS

TOLERANCES: CABLE LENGTH (L) TOLERANCES:

.X = ±.2 [5.08]	FRACTIONS	L ≤ 12 [305] = +1 [25] / -0
.XX = ±.02 [.51]	± 1/32	12 [305] < L ≤ 60 [1524] = +2 [51] / -0
.XXX = ±.005 [.13]	ANGLES ± 1°	60 [1524] < L ≤ 120 [3048] = +4 [102] / -0
		120 [3048] < L ≤ 300 [7620] = +6 [152] / -0
		300 [7620] < L = +5%L / -0

THIRD-ANGLE PROJECTION

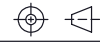

THE INFORMATION AND DESIGN IN THIS DOCUMENT IS THE PROPERTY OF FAIRVIEW MICROWAVE CORPORATION. ALL RIGHTS RESERVED.

SHEET 1 OF 1

ALL DIMENSIONS SHOWN ARE FOR REFERENCE ONLY.

SCALE N/A

SIZE A	CAGE CODE 3FKR5	DRAWN BY DZINN	ITEM NO. FMCN1624	REV A
-----------	--------------------	-------------------	----------------------	----------

T-Rev.D